

**EX-B760M-V7 II**



**Motherboard**

E26172  
First Edition  
April 2025

**Copyright © 2025 ASUSTeK COMPUTER INC. All Rights Reserved.**

No part of this manual, including the products and software described in it, may be reproduced, transmitted, transcribed, stored in a retrieval system, or translated into any language in any form or by any means, except documentation kept by the purchaser for backup purposes, without the express written permission of ASUSTeK COMPUTER INC. ("ASUS").

Product warranty or service will not be extended if: (1) the product is repaired, modified or altered, unless such repair, modification or alteration is authorized in writing by ASUS; or (2) the serial number of the product is defaced or missing.

ASUS PROVIDES THIS MANUAL "AS IS" WITHOUT WARRANTY OF ANY KIND, EITHER EXPRESS OR IMPLIED, INCLUDING BUT NOT LIMITED TO THE IMPLIED WARRANTIES OR CONDITIONS OF MERCHANTABILITY OR FITNESS FOR A PARTICULAR PURPOSE. IN NO EVENT SHALL ASUS, ITS DIRECTORS, OFFICERS, EMPLOYEES OR AGENTS BE LIABLE FOR ANY INDIRECT, SPECIAL, INCIDENTAL, OR CONSEQUENTIAL DAMAGES (INCLUDING DAMAGES FOR LOSS OF PROFITS, LOSS OF BUSINESS, LOSS OF USE OR DATA, INTERRUPTION OF BUSINESS AND THE LIKE), EVEN IF ASUS HAS BEEN ADVISED OF THE POSSIBILITY OF SUCH DAMAGES ARISING FROM ANY DEFECT OR ERROR IN THIS MANUAL OR PRODUCT.

SPECIFICATIONS AND INFORMATION CONTAINED IN THIS MANUAL ARE FURNISHED FOR INFORMATIONAL USE ONLY, AND ARE SUBJECT TO CHANGE AT ANY TIME WITHOUT NOTICE, AND SHOULD NOT BE CONSTRUED AS A COMMITMENT BY ASUS. ASUS ASSUMES NO RESPONSIBILITY OR LIABILITY FOR ANY ERRORS OR INACCURACIES THAT MAY APPEAR IN THIS MANUAL, INCLUDING THE PRODUCTS AND SOFTWARE DESCRIBED IN IT.

Products and corporate names appearing in this manual may or may not be registered trademarks or copyrights of their respective companies, and are used only for identification or explanation and to the owners' benefit, without intent to infringe.

# Contents

|   |   |
|---|---|
| Safety information.....                     | 4 |
| About this guide.....                       | 6 |
| Package contents.....                       | 8 |
| EX-B760M-V7 II specifications summary ..... | 9 |

## Chapter 1: Product Introduction

|       |                            |    |
|-------|----------------------------|----|
| 1.1   | Before you proceed .....   | 12 |
| 1.2   | Motherboard layout .....   | 13 |
| 1.2.1 | Layout contents .....      | 14 |
| 1.2.2 | Rear I/O connection.....   | 19 |
| 1.2.3 | LAN port LEDs .....        | 20 |
| 1.2.4 | Audio I/O connections..... | 20 |
| 1.3   | CPU installation .....     | 21 |
| 1.4   | DIMM installation .....    | 23 |

## Chapter 2: BIOS Information

|     |                          |    |
|-----|--------------------------|----|
| 2.1 | BIOS Setup program ..... | 25 |
| 2.2 | I-Cafe .....             | 26 |
| 2.3 | Main menu .....          | 29 |
| 2.4 | Advanced menu .....      | 30 |
| 2.5 | Monitor menu .....       | 32 |
| 2.6 | Boot menu.....           | 33 |
| 2.7 | Exit menu .....          | 34 |

## Appendix

|                                   |    |
|-----------------------------------|----|
| General notices.....              | 35 |
| Notices for non Wi-Fi model ..... | 38 |
| Warranty.....                     | 40 |
| ASUS contact information .....    | 43 |
| Service and support .....         | 43 |
| Product register.....             | 43 |

## Safety information

### Electrical safety



- To prevent electrical shock hazard, disconnect the power cable from the electrical outlet before relocating the system.
- When adding or removing devices to or from the system, ensure that the power cables for the devices are unplugged before the signal cables are connected. If possible, disconnect all power cables from the existing system before you add a device.
- Before connecting or removing signal cables from the motherboard, ensure that all power cables are unplugged.
- Seek professional assistance before using an adapter or extension cord. These devices could interrupt the grounding circuit.
- Ensure that your power supply is set to the correct voltage in your area. If you are not sure about the voltage of the electrical outlet you are using, contact your local power company.
- If the power supply is broken, do not try to fix it by yourself. Contact a qualified service technician or your retailer.

### Operation safety

- Before installing the motherboard and adding devices on it, carefully read all the manuals that came with the package.
- Before using the product, ensure all cables are correctly connected and the power cables are not damaged. If you detect any damage, contact your dealer immediately.
- To avoid short circuits, keep paper clips, screws, and staples away from connectors, slots, sockets and circuitry.
- Avoid dust, humidity, and temperature extremes. Do not place the product in any area where it may become wet.
- Place the product on a stable surface.
- If you encounter technical problems with the product, contact a qualified service technician or your retailer.
- Your motherboard should only be used in environments with ambient temperatures between 10°C and 35°C.

## Button/Coin Batteries Safety Information

1. Remove and immediately recycle or dispose of used batteries according to local regulations and keep out of reach of children. Do not incinerate or dispose of batteries in household trash.
2. If ingested or inserted inside any part of the body, call a local poison control center for treatment information. Even used batteries may cause serious injury or death.
3. This product uses CR2032 type batteries with a nominal voltage of 3V.
4. Do not attempt to recharge non-rechargeable batteries.
5. Do not forcibly discharge, recharge, disassemble, heat above the battery manufacturer's specified temperature rating, or incinerate. Doing so may result in injury or chemical burns caused by venting, leakage, or explosion.
6. This product contains non-replaceable batteries.

|  <b>WARNING</b>  |   |
|---|---|
| <ul style="list-style-type: none"><li>• <b>INGESTION HAZARD:</b> This product contains a button cell or coin battery.</li><li>• <b>DEATH</b> or serious injury can occur if ingested.</li><li>• A swallowed button cell or coin battery can cause <b>Internal Chemical Burns</b> in as little as <b>2 hours</b>.</li><li>• <b>KEEP</b> new and used batteries <b>OUT OF REACH of CHILDREN</b>.</li><li>• <b>Seek immediate medical attention</b> if a battery is suspected to be swallowed or inserted inside any part of the body.</li></ul> |  |

## About this guide

This user guide contains the information you need when installing and configuring the motherboard.

## How this guide is organized

This guide contains the following parts:

- **Chapter 1: Product Introduction**  
This chapter describes the features of the motherboard and includes descriptions for each part of the motherboard.
- **Chapter 2: BIOS Information**  
This chapter tells how to boot into the BIOS.

## Where to find more information

Refer to the following sources for additional information and for product and software updates.

1. **ASUS website**  
The ASUS website ([www.asus.com](http://www.asus.com)) provides updated information on ASUS hardware and software products.
2. **Optional documentation**  
Your product package may include optional documentation, such as warranty flyers, that may have been added by your dealer. These documents are not part of the standard package.
3. **Motherboard Installation Guide**  
Please visit <https://www.asus.com/support> for more information on the Motherboard Installation Guide.



4. **Driver and Utilities FAQ**  
Please visit <https://www.asus.com/support> for more information on downloading and installing drivers and utilities for your motherboard.



## Conventions used in this guide

To ensure that you perform certain tasks properly, take note of the following notes used throughout this user guide.

|                  |  |
|------------------|--|
| <b>CAUTION</b>   | Information to prevent damage to the components and injuries to yourself when trying to complete a task. |
| <b>IMPORTANT</b> | Instructions that you <b>MUST</b> follow to complete a task.   |
| <b>NOTE</b>      | Tips and additional information to help you complete a task.   |

# Package contents

Check your motherboard package for the following items.

---

|               |  |
|---------------|--|
| Motherboard   | 1 x EX-B760M-V7 II motherboard           |
| Cables        | 2 x SATA 6Gb/s cables                    |
| Miscellaneous | 1 x I/O Shield<br>1 x M.2 anchor package |
| Documentation | 1 x Quick start guide                    |

---

**NOTE:**

- If any of the above items is damaged or missing, contact your retailer.
  - Items not listed in the Package contents list above are purchased separately and do not come bundled with your motherboard package.
-

## EX-B760M-V7 II specifications summary

|                 |   |
|-----------------|---|
| CPU             | <p>Intel® Socket LGA1700 for Intel® Core™ 14<sup>th</sup> &amp; 13<sup>th</sup> Gen Processors, Intel® Core™ 12<sup>th</sup> Gen, Pentium® Gold and Celeron® Processors*</p> <p>Supports Intel® Turbo Boost Technology 2.0 and Intel® Turbo Boost Max Technology 3.0**</p> <p>* Refer to <a href="https://www.asus.com/support/download-center/">https://www.asus.com/support/download-center/</a> for CPU support list.</p> <p>** Intel® Turbo Boost Max Technology 3.0 support depends on the CPU types.</p>  |
| Chipset         | Intel® B760 Chipset   |
| Memory          | <p>2 x DIMM slots, Max. 96GB, DDR5</p> <p>Supports up to 8000+MT/s (OC) Non-ECC, Un-buffered Memory*</p> <p>Dual channel memory architecture</p> <p>Supports Intel® Extreme Memory Profile (XMP) memory module</p> <p>* Supported memory types, data rate (speed), and number of DRAM modules vary depending on the CPU and memory configuration, for more information please refer to CPU/Memory Support list under the Support tab of product information site or visit <a href="https://www.asus.com/support/download-center/">https://www.asus.com/support/download-center/</a>. Adjustments will be made based on the specifications of mass-produced memory products available on the market.</p> <p>* Non-ECC, un-buffered DDR5 memory supports On-Die ECC function.</p> |
| Graphics        | <p>1 x DisplayPort**</p> <p>1 x HDMI™ port***</p> <p>* Graphics specifications may vary between CPU types. Please refer to <a href="http://www.intel.com">www.intel.com</a> for any updates.</p> <p>** Supports max. 4K@60Hz as specified in DisplayPort 1.4.</p> <p>*** Supports 4K@60Hz as specified in HDMI 2.1.</p> <p>****VGA resolution support depends on processors' or graphic cards' resolution.</p>  |
| Expansion Slots | <p><b>Intel® Core™ Processors (14<sup>th</sup> &amp; 13<sup>th</sup> &amp; 12<sup>th</sup> Gen)</b></p> <p>- 1 x PCIe 5.0 x16 slot</p> <p><b>Intel® B760 Chipset</b></p> <p>- 1 x PCIe 4.0 x16 slot (supports x4 mode)</p> <p>* To ensure compatibility of the device installed, please refer to <a href="https://www.asus.com/support/download-center/">https://www.asus.com/support/download-center/</a> for the list of supported peripherals.</p>   |
| Storage         | <p><b>Total supports 2 x M.2 slots and 4 x SATA 6Gb/s ports*</b></p> <p><b>Intel® Core™ Processors (14<sup>th</sup> &amp; 13<sup>th</sup> &amp; 12<sup>th</sup> Gen)</b></p> <p>- M.2_1 slot (Key M), type 2242/2260/2280 (supports PCIe 4.0 x4 mode)</p> <p><b>Intel® B760 Chipset</b></p> <p>- M.2_2 slot (Key M), type 2242/2260/2280 (supports PCIe 4.0 x4 mode)</p> <p>- 4 x SATA 6Gb/s ports</p> <p>* Intel® Rapid Storage Technology supports SATA RAID 0/1/5/10.</p>  |
| Ethernet        | <p>1 x Realtek 2.5Gb Ethernet</p> <p>ASUS LANGuard</p>  |
| USB             | <p><b>Rear USB (Total 6 ports)</b></p> <p>4 x USB 5Gbps ports (4 x Type-A)</p> <p>2 x USB 2.0 ports (2 x Type-A)</p> <p><b>Front USB (Total 5 ports)</b></p> <p>1 x USB 5Gbps header supports 2 additional USB 5Gbps ports</p> <p>2 x USB 2.0 headers support 3 additional USB 2.0 ports</p>  |

(continued on the next page)

## EX-B760M-V7 II specifications summary

|                                       |   |
|---------------------------------------|---|
| <p><b>Audio</b></p>                   | <p>Realtek 7.1 Surround Sound High Definition Audio CODEC*</p> <ul style="list-style-type: none"> <li>- Supports: Jack-detection, Multi-streaming, Front Panel Jack-retasking</li> <li>- Supports up to 24-Bit/192 kHz playback</li> </ul> <p><b>Audio Features</b></p> <ul style="list-style-type: none"> <li>- Audio Shielding</li> <li>- Premium audio capacitors</li> <li>- Dedicated audio PCB layers</li> </ul> <p>* A chassis with an HD audio module in the front panel is required to support 7.1 Surround Sound audio output.</p>   |
| <p><b>Back Panel I/O Ports</b></p>    | <p>4 x USB 5Gbps ports (4 x Type-A)<br/>                 2 x USB 2.0 ports (2 x Type-A)<br/>                 1 x DisplayPort<br/>                 1 x HDMI™ port<br/>                 1 x Realtek 2.5Gb Ethernet port<br/>                 3 x Audio jacks</p>  |
| <p><b>Internal I/O connectors</b></p> | <p><b>Fan and Cooling Related</b></p> <ul style="list-style-type: none"> <li>1 x 4-pin CPU Fan header</li> <li>2 x 4-pin Chassis Fan headers</li> </ul> <p><b>Power Related</b></p> <ul style="list-style-type: none"> <li>1 x 24-pin Main Power connector</li> <li>1 x 8-pin +12V CPU Power connector</li> </ul> <p><b>Storage Related</b></p> <ul style="list-style-type: none"> <li>2 x M.2 slots (Key M)</li> <li>4 x SATA 6Gb/s ports</li> </ul> <p><b>USB</b></p> <ul style="list-style-type: none"> <li>1 x USB 5Gbps header supports 2 additional USB 5Gbps ports</li> <li>2 x USB 2.0 headers support 3 additional USB 2.0 ports</li> </ul> <p><b>Miscellaneous</b></p> <ul style="list-style-type: none"> <li>1 x Clear CMOS header</li> <li>1 x COM Port header</li> <li>1 x Front Panel Audio header (F_AUDIO)</li> <li>1 x 10-1 pin Front Panel System header</li> </ul> |
| <p><b>Special Features</b></p>        | <p><b>ASUS 5X PROTECTION III</b></p> <ul style="list-style-type: none"> <li>- DIGI+ VRM</li> <li>- LANGuard</li> <li>- Overvoltage Protection</li> <li>- SafeSlot</li> <li>- Stainless-Steel Back I/O</li> </ul>  |

*(continued on the next page)*

## EX-B760M-V7 II specifications summary

|                   |  |
|-------------------|--|
| Special Features  | <b>ASUS Q-Design</b> <ul style="list-style-type: none"><li>- Q-DIMM</li><li>- Q-LED Core</li><li>- Q-Slot</li></ul>            |
|                   | <b>ASUS Thermal Solution</b> <ul style="list-style-type: none"><li>- VRM heatsink design</li></ul>                             |
|                   | <b>ASUS EZ DIY</b> <ul style="list-style-type: none"><li>- ProCool</li></ul>   |
|                   | <b>Non-stop Action</b> <ul style="list-style-type: none"><li>- Lightning Boot</li></ul>  |
|                   | <b>Non-stop Challenger</b> <ul style="list-style-type: none"><li>- ASUS iCafe labs certified</li></ul>                         |
|                   | <b>Non-stop Durability</b> <ul style="list-style-type: none"><li>- Luminous anti-moisture coating</li><li>- USBGuard</li></ul> |
|                   | BIOS   |
| BIOS CAP Filename | <b>EX-B760M-V7 II:</b> EB760M72.CAP  |
| Manageability     | WOL by PME, PXE  |
| Operating System  | Windows® 11  |
|                   | Windows® 10 64-bit   |
| Form Factor       | micro-ATX Form Factor<br>9.6 inch x 8.3 inch (24.4cm x 21.1cm)   |

**NOTE:** Specifications are subject to change without notice. Please refer to the ASUS website for the latest specifications.

# Product Introduction

## 1.1 Before you proceed

Take note of the following precautions before you install motherboard components or change any motherboard settings.

---

**CAUTION!**

- Unplug the power cord from the wall socket before touching any component.
- Before handling components, use a grounded wrist strap or touch a safely grounded object or a metal object, such as the power supply case, to avoid damaging them due to static electricity.
- Hold components by the edges to avoid touching the ICs on them.
- Whenever you uninstall any component, place it on a grounded antistatic pad or in the bag that came with the component.
- Before you install or remove any component, ensure that the power supply is switched off or the power cord is detached from the power supply. Failure to do so may cause severe damage to the motherboard, peripherals, or components.

---

**NOTE:**

- The pin definitions in this chapter are for reference only. The pin names depend on the location of the header/jumper/connector.
  - The illustrations for this chapter are for reference only.
-

# 1.2 Motherboard layout

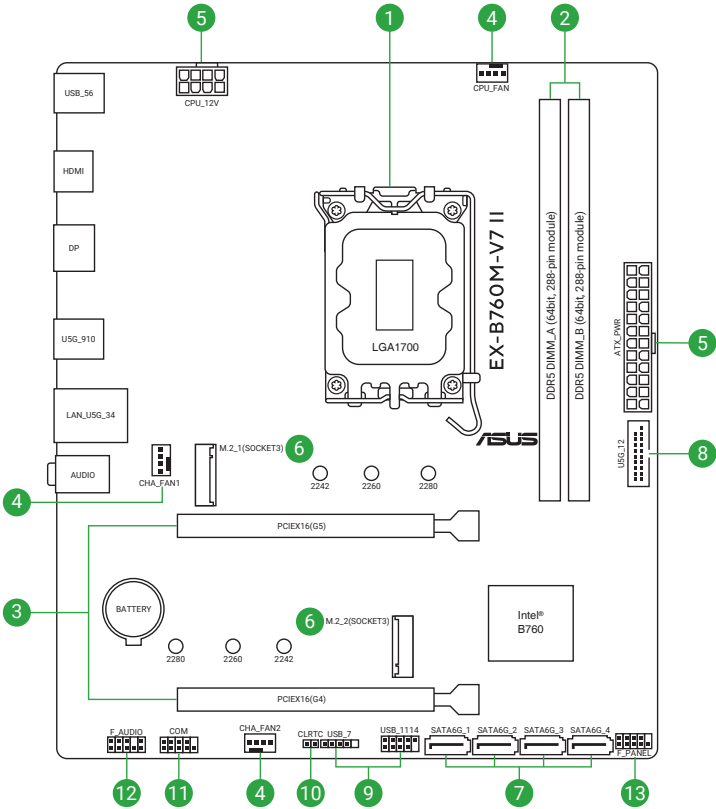

## 1.2.1 Layout contents

### 1. CPU socket

The motherboard comes with an Intel® Socket LGA1700 for Intel® Core™ 14<sup>th</sup> & 13<sup>th</sup> Gen Processors, Intel® Core™ 12<sup>th</sup> Gen, Pentium® Gold and Celeron® Processors.

---

**NOTE:** For more details, refer to **CPU installation**.

---

### 2. DIMM slots

The motherboard comes with Dual Inline Memory Modules (DIMM) slots designed for DDR5 (Double Data Rate 5) memory modules.

---

**NOTE:** For more details, refer to **DIMM installation**.

---

### 3. Expansion slots

This motherboard supports two PCIe x16 graphics cards that comply with the PCI Express specification.

### 4. Fan headers

The Fan headers allow you to connect fans to cool the system.



| Header   | Max. Current | Max. Power | Default Speed    | Shared Control |
|----------|--------------|------------|------------------|----------------|
| CPU_FAN  | 1A           | 12W        | Q-Fan Controlled | -              |
| CHA_FAN1 | 1A           | 12W        | Q-Fan Controlled | -              |
| CHA_FAN2 | 1A           | 12W        | Q-Fan Controlled | -              |

---

**CAUTION!**

- DO NOT forget to connect the fan cables to the fan headers. Insufficient air flow inside the system may damage the motherboard components. These are not jumpers! Do not place jumper caps on the fan headers!
  - Ensure the cable is fully inserted into the header.
-

## 5. Power connectors

These Power connectors allow you to connect your motherboard to a power supply. The power supply plugs are designed to fit in only one orientation. Find the proper orientation and push down firmly until the power supply plugs are fully inserted.

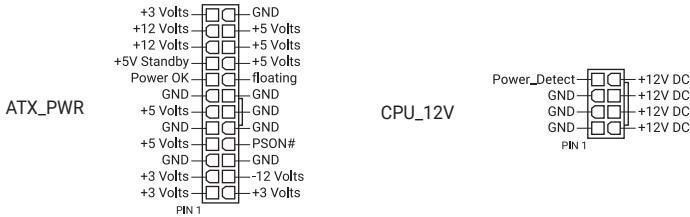

**CAUTION!** Ensure to connect the 8-pin power plug.

### NOTE:

- We recommend that you use a PSU with a higher power output when configuring a system with more power-consuming devices. The system may become unstable or may not boot up if the power is inadequate.
- PSU input: AC 100~240V, 6A/3A, 50/60Hz.

## 6. M.2 slot

The M.2 slot allows you to install M.2 devices such as M.2 SSD modules.

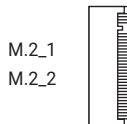

### NOTE:

- **Intel® Core™ Processors (14<sup>th</sup> & 13<sup>th</sup> & 12<sup>th</sup> Gen)**  
M.2\_1 slot (Key M), type 2242/2260/2280 (supports PCIe 4.0 x4 mode)
- **Intel® B760 Chipset:**  
M.2\_2 slot (Key M), type 2242/2260/2280 (supports PCIe 4.0 x4 mode)

## 7. SATA 6Gb/s connector

The SATA 6Gb/s connector allows you to connect SATA devices such as optical disc drives and hard disk drives via a SATA cable.



**NOTE:**

- If you installed SATA storage devices to the **SATA6G\_1-4** ports, you can create RAID configurations through the onboard Intel® B760 chipset.
- To install a SATA device, please refer to the **Motherboard Installation Guide** on the ASUS support site.
- Before creating a RAID set, refer to the **RAID Configuration Guide**. You can download the **RAID Configuration Guide** from the ASUS support site.

## 8. USB 5Gbps header

The USB 5Gbps header allows you to connect a USB 5Gbps module for additional USB 5Gbps ports. The USB 5Gbps header provides data transfer speeds of up to 5 Gb/s.

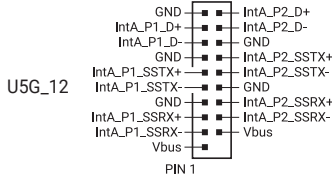

## 9. USB 2.0 header

The USB 2.0 header allows you to connect a USB module for additional USB 2.0 ports. The USB 2.0 header provides data transfer speeds of up to 480 Mb/s.

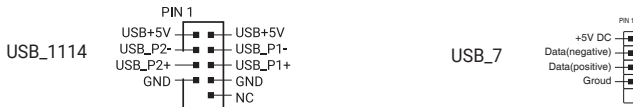

**CAUTION!** DO NOT connect a 1394 cable to the USB connectors. Doing so will damage the motherboard!

## 10. Clear CMOS header

The Clear CMOS header allows you to clear the Real Time Clock (RTC) RAM in the CMOS, which contains the date, time, system passwords, and system setup parameters.

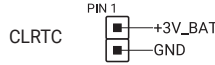

To erase the RTC RAM:

1. Turn OFF the computer and unplug the power cord.
2. Short-circuit pin 1-2 with a metal object or jumper cap for about 5-10 seconds.
3. Plug the power cord and turn ON the computer.
4. Hold down the <Del> key during the boot process and enter BIOS setup to re-enter data.

---

**CAUTION!** DO NOT short-circuit the pins except when clearing the RTC RAM. Short-circuiting or placing a jumper cap will cause system boot failure!

---

## 11. COM Port connector

The COM (Serial) Port connector allows you to connect a COM port module. Connect the COM port module cable to this connector, then install the module to a slot opening on the system chassis.

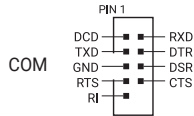

## 12. Front Panel Audio header

The Front Panel Audio header is for a chassis-mounted front panel audio I/O module that supports HD Audio. Connect one end of the front panel audio I/O module cable to this header.

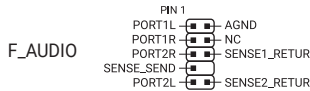

### 13. Front Panel System header

The Front Panel System header supports several chassis-mounted functions.

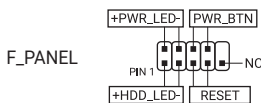

- **System Power LED header (+PWR\_LED-)**

The 2-pin header allows you to connect the System Power LED. The System Power LED lights up when the system is connected to a power source, or when you turn on the system power, and blinks when the system is in sleep mode.

- **Storage Device Activity LED header (+HDD\_LED-)**

The 2-pin header allows you to connect the Storage Device Activity LED. The Storage Device Activity LED lights up or blinks when data is read from or written to the storage device or storage device add-on card.

- **Power Button/Soft-off Button header (PWR\_BTN)**

The 3-1 pin header allows you to connect the system power button. Press the power button to power up the system, or put the system into sleep or soft-off mode (depending on the operating system settings).

- **Reset button header (RESET)**

The 2-pin header allows you to connect the chassis-mounted reset button. Press the reset button to reboot the system.

---

**NOTE:** This header is set to **[Reset]** by default. You can assign a different function to this header in the BIOS settings.

---

## 1.2.2 Rear I/O connection

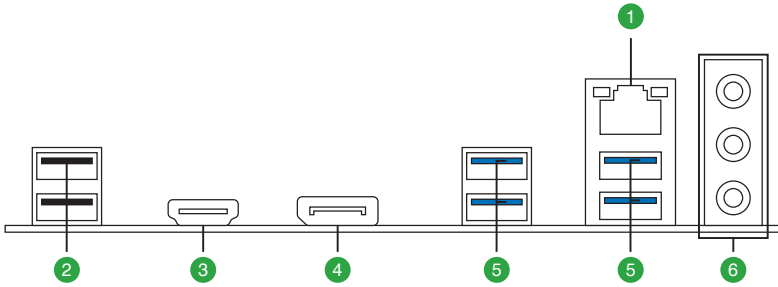

### Rear panel connectors

- |    |  |
|----|--|
| 1. | Realtek 2.5Gb Ethernet port*           |
| 2. | USB 2.0 ports 5 and 6                  |
| 3. | HDMI™ port                             |
| 4. | DisplayPort                            |
| 5. | USB 5Gbps Type-A ports 3, 4, 9, and 10 |
| 6. | Audio jacks**                          |

\* and \*\*: Refer to the tables under LAN port LEDs, and Audio I/O connections sections.

**NOTE:** We strongly recommend that you connect your devices to ports with matching data transfer rate. For example connecting your USB 5Gbps devices to USB 5Gbps ports for faster and better performance for your devices.

### 1.2.3 LAN port LEDs

Realtek 2.5Gb Ethernet port LED indications

| Activity Link LED |               | Speed LED |  |
|-------------------|---------------|-----------|--|
| Status            | Description   | Status    | Description                            |
| OFF               | No link       | OFF       | No link                                |
| GREEN             | Linked        | GREEN     | 2.5 Gbps connection                    |
| BLINKING          | Data activity | ORANGE    | 1 Gbps / 100 Mbps / 10 Mbps connection |

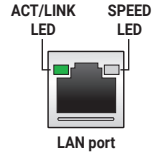

### 1.2.4 Audio I/O connections

Audio 2, 4, 5.1 or 7.1-channel configuration

| Port               | 2-channel         | 4-channel         | 5.1-channel       | 7.1-channel       |
|--------------------|-------------------|-------------------|-------------------|-------------------|
| <b>Rear panel</b>  |                   |                   |                   |                   |
| LINE IN            | -                 | Rear Speaker Out  | Rear Speaker Out  | Rear Speaker Out  |
| LINE OUT           | Front Speaker Out | Front Speaker Out | Front Speaker Out | Front Speaker Out |
| MIC IN             | -                 | -                 | Center/ Subwoofer | Center/ Subwoofer |
| <b>Front panel</b> |                   |                   |                   |                   |
| HEADPHONE (Lime)   | -                 | -                 | -                 | Side Speaker Out  |
| MIC IN (Pink)      | -                 | -                 | -                 | -                 |

## 1.3 CPU installation

---

### CAUTION!

- Ensure that you install the correct CPU designed for LGA1700 socket only. DO NOT install a CPU designed for LGA1155, LGA1156, LGA1151, and LGA1200 sockets on the LGA1700 socket.
  - The CPU fits in only one correct orientation. DO NOT force the CPU into the socket to prevent bending the connectors on the socket and damaging the CPU.
  - Ensure that all power cables are unplugged before installing the CPU.
  - Upon purchase of the motherboard, ensure that the PnP cap is on the socket and the socket contacts are not bent. Contact your retailer immediately if the PnP cap is missing, or if you see any damage to the PnP cap/socket contacts/motherboard components. ASUS will shoulder the cost of repair only if the damage is shipment/transit-related.
  - Keep the cap after installing the motherboard. ASUS will process Return Merchandise Authorization (RMA) requests only if the motherboard comes with the cap on the CPU socket.
  - The product warranty does not cover damage to the socket contacts resulting from incorrect CPU installation/removal, or misplacement/loss/incorrect removal of the PnP cap.
- 

**IMPORTANT!** Install a heatsink or AIO cooler after installing the CPU. Please refer to the **Motherboard Installation Guide** on the ASUS support site, or to the user manual of the heatsink/AIO cooler for steps on installing the heatsink/AIO cooler.

---

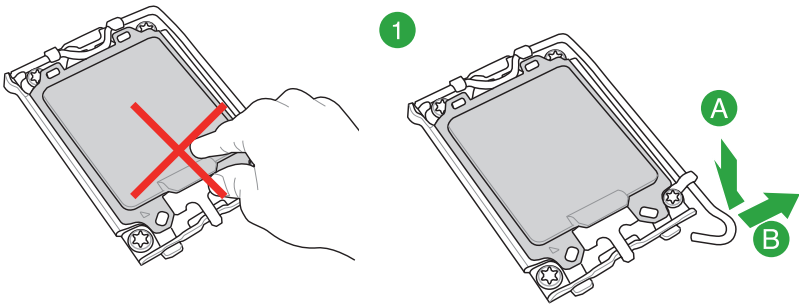

**CAUTION!** Take caution when lifting the load lever, ensure to hold onto the load lever when releasing the load lever. Letting go of the load lever immediately after releasing it may cause the load lever to spring back and cause damage to your motherboard.

---

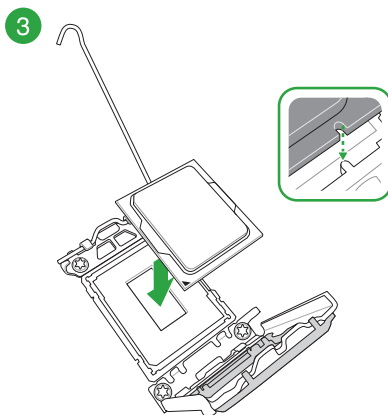
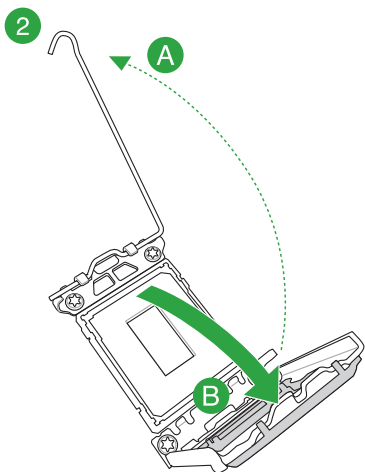

**IMPORTANT!** Ensure the notches on the CPU are properly aligned to the tabs in the CPU socket, and the triangle mark on the CPU is aligned to the same corner as the triangle mark on the socket.

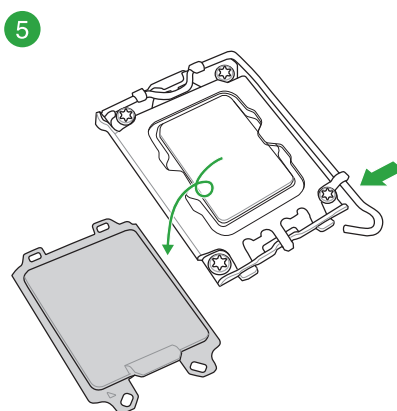
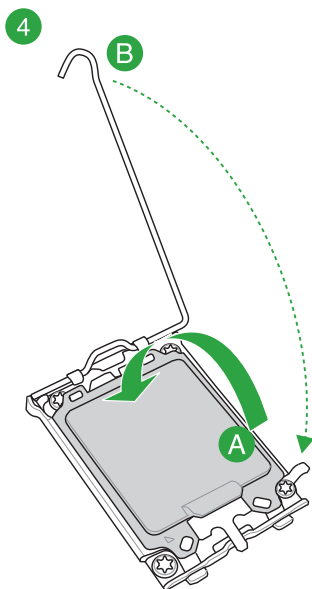

## 1.4 DIMM installation

The figure illustrates the location of the DDR5 DIMM sockets.



---

**CAUTION!** A DDR5 memory module is notched differently from a DDR, DDR2, DDR3, or DDR4 module. DO NOT install a DDR, DDR2, DDR3, or DDR4 memory module to the DDR5 slot.

---

### Recommended memory configurations

| Memory configurations | DIMM |   |
|-----------------------|------|---|
|                       | A    | B |
| 1 DIMM                | ✓    |   |
| 2 DIMMs               | ✓    | ✓ |

You may install Non-ECC DDR5 DIMMs into the DIMM sockets.

---

**NOTE:**

- The default memory operation frequency is dependent on its Serial Presence Detect (SPD), which is the standard way of accessing information from a memory module. Under the default state, some memory modules for overclocking may operate at a lower frequency than the vendor-marked value.
  - For system stability, use a more efficient memory cooling system to support a full memory load or overclocking condition.
  - Always install the DIMMs with the same CAS Latency. For an optimum compatibility, we recommend that you install memory modules of the same version or data code (D/C) from the same vendor. Check with the vendor to get the correct memory modules.
  - Visit the ASUS website for the latest QVL.
-

## Installing a DIMM

1

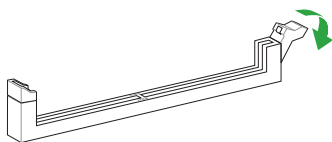

2

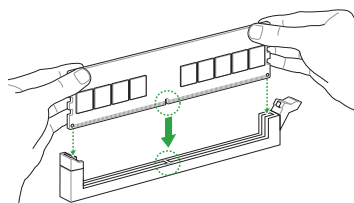

3

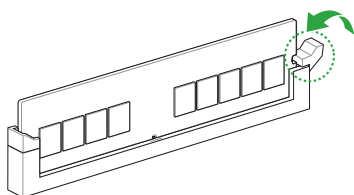

## Removing a DIMM

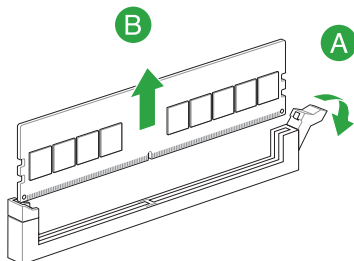

# BIOS Information

## 2.1 BIOS Setup program

Use the BIOS Setup to update the BIOS or configure its parameters. The BIOS screens include navigation keys and brief onscreen help to guide you in using the BIOS Setup program.

### Entering BIOS at startup

To enter BIOS Setup at startup, press <Delete> or <F2> during the Power-On Self Test (POST). If you do not press <Delete> or <F2>, POST continues with its routines.

### Entering BIOS Setup after POST

To enter BIOS Setup after POST:

- Press <Ctrl>+<Alt>+<Delete> simultaneously.
- Press the reset button on the system chassis.
- Press the power button to turn the system off then back on. Do this option only if you failed to enter BIOS Setup using the first two options.

After doing either of the three options, press <Delete> key to enter BIOS.

---

#### IMPORTANT!

- Ensure that a USB mouse is connected to your motherboard if you want to use the mouse to control the BIOS Setup program.
  - If the system becomes unstable after changing any BIOS setting, load the default settings to ensure system compatibility and stability. Select the **Load Optimized Defaults** item under the **Exit** menu or press hotkey <F5>.
  - If the system fails to boot after changing any BIOS setting, try to clear the CMOS and reset the motherboard to the default value.
  - The BIOS Setup program does not support Bluetooth devices.
- 

### BIOS menu screen

The BIOS Setup program can be used under the **Advanced Mode**.

## 2.2 I-Cafe

The items in this menu allows you to configure some quick settings for the I-Cafe feature.

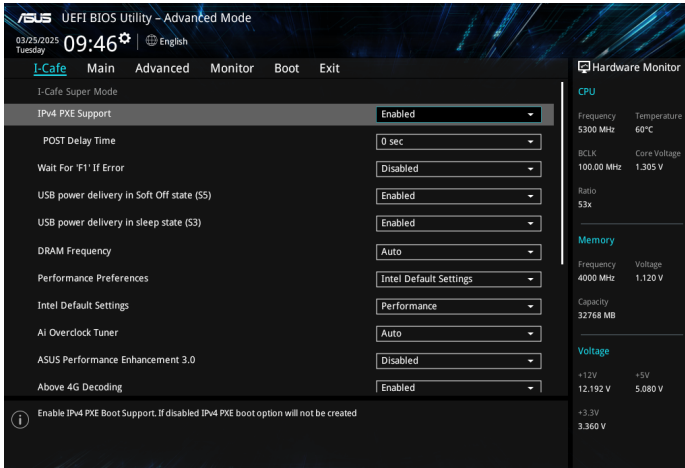

### IPv4 PXE Support

This item allows you to enable IPv4 PXE Boot Support. If disabled, IPv4 PXE Boot option will not be created.

### POST Delay Time

This item appears only when you set Boot Logo Display to [Auto] and [Full Screen]. This item allows you to select the desired additional POST waiting time to easily enter the BIOS Setup. You can only execute the POST delay time during Normal Boot. The values range from 0 to 10 seconds.

### Wait for 'F1' If Error

When this item is set to [Enabled], the system waits for the <F1> key to be pressed when error occurs.

### USB power delivery in Soft Off state (S5)

[Enabled] Charges USB devices even when the system is in Power State S5.

[Disabled] Disables this function.

### USB power delivery in Sleep state (S3)

[Enabled] Charges USB devices even when the system is in Power State S3.

[Disabled] Disables this function.

## DRAM Frequency

Allows you to select the DRAM operating frequency. Select the Auto mode to apply the optimized settings.

## Performance Preferences

Allows you to adjust the processor performance and power limit related settings based on your preferences.

## Intel Default Settings

Allows you to load the Intel® default settings and operate within Intel®'s recommended parameters.

## AI Overclock Tuner

This item allows you to automatically adjust CPU and RAM overclocking settings, including pre-configured profiles for optimal overclocking settings (DOCP and XMP), and AEMP, which automatically loads a pre-configured memory profile when no DIMM profiles are detected.

## ASUS Performance Enhancement 3.0

This item allows the CPU to maintain boost frequencies longer for a better performance.

## Above 4G decoding

Allows you to enable or disable 64bit capable Devices to be Decoded in Above 4G Address Space (Only if System supports 64 bit PCI Decoding).

## Re-Size BAR Support

Allows you to enable or disable Re-Size BAR Support function.

## Lightning Boot

Enable the item to speed up BIOS boot time.

## ASUS EZ Flash 3 Utility

Allows you to run ASUS EZ Flash 3. Press <Enter> to launch the ASUS EZ Flash 3 screen.

## VMD setup menu

The subitems in this menu allow you to set the VMD related features.

## RGB LED lighting

[On] Turns on the RGB LEDs.

[Off] Turns off the RGB LEDs.

## Power button LED in sleep, hibernate or soft off states

[On] Turns on the power button LED.

[Off] Turns off the power button LED.

## Internal CPU Power Management

The subitems in this menu allow you to set the CPU ratio and features.

## ASUS MyHotkey

Allows you to press the hotkey (FX) during POST to boot to the USB device / HDD device / CDROM device / PXE device / EZ Flash.

## 2.3 Main menu

The Main menu screen appears when you enter the Advanced Mode of the BIOS Setup program. The Main menu provides you an overview of the basic system information, and allows you to set the system date, time, language, and security settings.

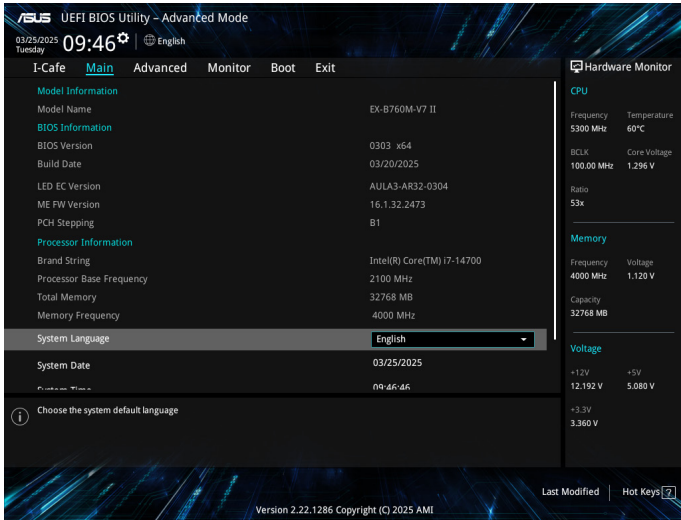

### System Language [English]

Allows you to choose the BIOS language version from the options.

### System Date [Day xx/xx/xxxx]

Allows you to set the system date.

### System Time [xx:xx:xx]

Allows you to set the system time.

### Security

The Security menu items allow you to change the system security settings.

---

#### NOTE:

- If you have forgotten your BIOS password, erase the CMOS Real Time Clock (RTC) RAM to clear the BIOS password. See section **Motherboard layout** for information on how to erase the RTC RAM.
  - The **Administrator** or **User Password** items on top of the screen show the default **Not Installed**. After you set a password, these items show **Installed**.
-

## 2.4 Advanced menu

The Advanced menu items allow you to change the settings for the CPU and other system devices.

**CAUTION!** Be cautious when changing the settings of the Advanced menu items. Incorrect field values can cause the system to malfunction.

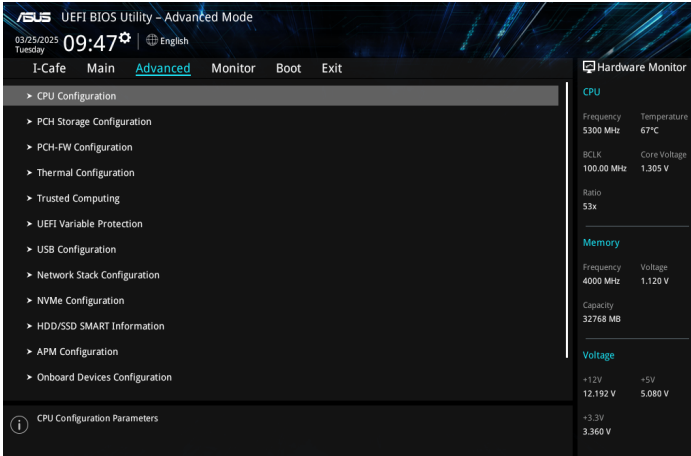

### CPU Configuration

The items in this menu show the CPU-related information that the BIOS automatically detects.

### PCH Storage Configuration

While entering Setup, the BIOS automatically detects the presence of SATA devices. The SATA Port items show Empty if no SATA device is installed to the corresponding SATA port.

### PCH-FW Configuration

The items in this menu allow you to configure the management engine technology settings.

### Thermal Configuration

The items in this menu allow you to configure thermal parameters.

### Trusted Computing

The items in this menu allow you to configure the trusted computing settings.

### UEFI Variables Protection

The items in this menu allow you to configure the NVRAM Runtime Variable Protection settings.

## **USB Configuration**

The items in this menu allow you to change the USB-related features.

## **Network Stack Configuration**

The items in this menu allow you to configure the network stack settings.

## **NVMe Configuration**

This menu displays the NVMe controller and Drive information of the connected devices.

## **HDD/SDD SMART Information**

This menu displays the SMART information of the connected devices.

## **APM Configuration**

The items in this menu allow you to configure the advanced power management settings.

## **Onboard Devices Configuration**

The items in this menu allow you to configure the onboard devices.

## **Intel(R) Rapid Storage Technology**

The item allows you to manage RAID volumes on the Intel(R) RAID Controller.

## **Realtek PCIe 2.5GBE Family Controller (MAC:00:E0:4C:68:00:0E)**

The item allows you to get driver information and configure Realtek ethernet controller parameter.

## 2.5 Monitor menu

The Monitor menu displays the system temperature/power status, and allows you to change the fan settings.

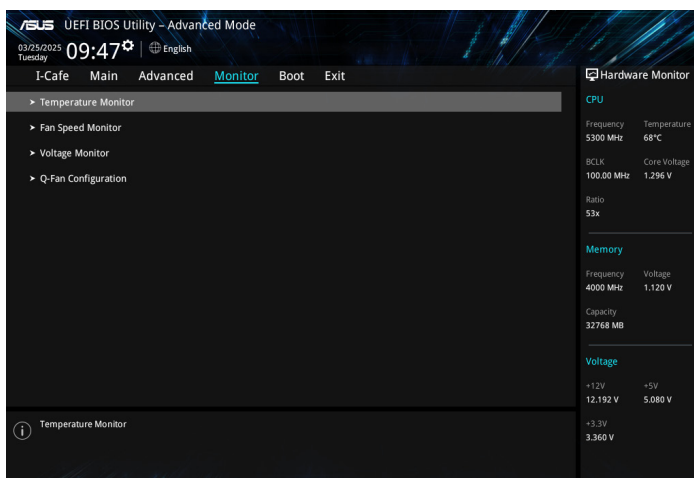

### Temperature Monitor

The onboard hardware monitor automatically detects and displays the CPU, CPU package and motherboard temperatures. Select **[Ignore]** if you do not wish to display the detected temperatures.

### Fan Speed Monitor

The onboard hardware monitor automatically detects and displays the CPU and chassis fan speeds in rotations per minute (RPM). If the fan is not connected to the motherboard, the field shows N/A. Select **[Ignore]** if you do not wish to display the detected speed.

### Voltage Monitor

The onboard hardware monitor automatically detects the voltage output through the onboard voltage regulators. Select **[Ignore]** if you do not want to detect this item.

### Q-Fan Configuration

The subitems in this menu allows you to configure the Q-Fan features.

## 2.6 Boot menu

The Boot menu items allow you to change the system boot options.

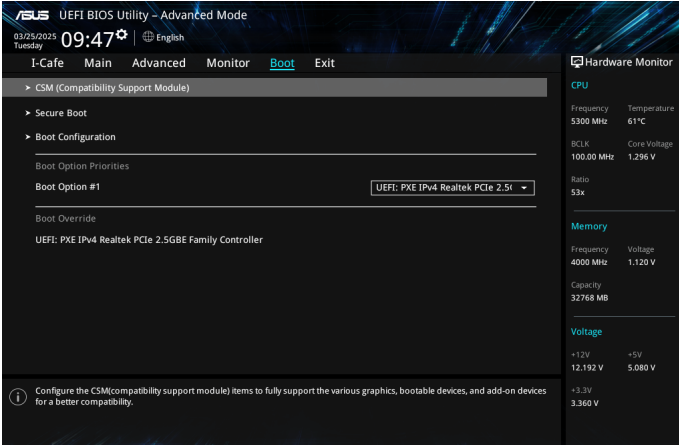

### CSM (Compatibility Support Module)

Allows you to configure the CSM (Compatibility Support Module) items to fully support the various VGA, bootable devices and add-on devices for better compatibility.

### Secure Boot

Allows you to configure the Windows® Secure Boot settings and manage its keys to protect the system from unauthorized access and malwares during POST.

### Boot Configuration

These subitems allow you to configure the boot configuration items.

### Boot Option Priorities

These items specify the boot device priority sequence from the available devices. The number of device items that appears on the screen depends on the number of devices installed in the system.

---

**NOTE:**

- To access Windows® OS in Safe Mode, press <F8> after POST (Windows® 8 not supported).
  - To select the boot device during system startup, press <F8> when ASUS Logo appears.
- 

### Boot Override

These items display the available devices. The number of device items that appears on the screen depends on the number of devices installed in the system. Click an item to start booting from the selected device.

## 2.7 Exit menu

The Exit menu items allow you to load the optimal default values for the BIOS items, and save or discard your changes to the BIOS items.

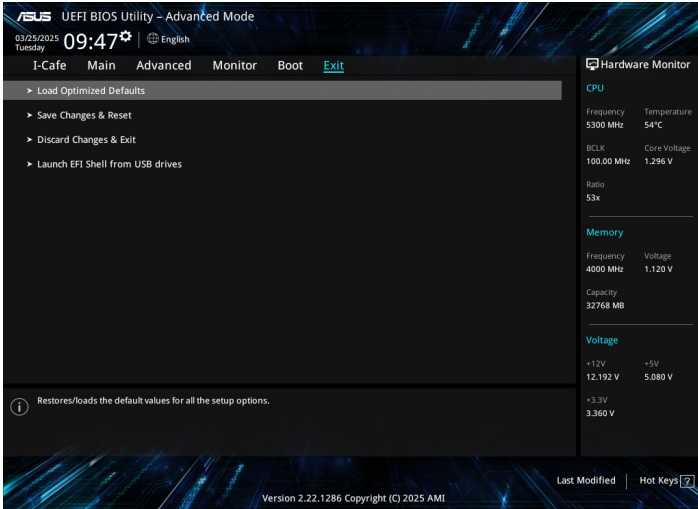

### Load Optimized Defaults

This option allows you to load the default values for each of the parameters on the Setup menus. When you select this option or if you press <F5>, a confirmation window appears. Select OK to load the default values.

### Save Changes & Reset

Once you are finished making your selections, choose this option from the Exit menu to ensure the values you selected are saved. When you select this option or if you press <F10>, a confirmation window appears. Select OK to save changes and exit.

### Discard Changes & Exit

This option allows you to exit the Setup program without saving your changes. When you select this option or if you press <Esc>, a confirmation window appears. Select OK to discard changes and exit.

### Launch EFI Shell from USB drives

This option allows you to attempt to launch the EFI Shell application (shellx64.efi) from one of the available USB devices.

# Appendix

## General notices

### FCC Compliance Information

Responsible Party: Asus Computer International

Address: 48720 Kato Rd., Fremont, CA 94538, USA

Phone / Fax No: (510)739-3777 / (510)608-4555

This device complies with part 15 of the FCC Rules. Operation is subject to the following two conditions: (1) This device may not cause harmful interference, and (2) this device must accept any interference received, including interference that may cause undesired operation.

This equipment has been tested and found to comply with the limits for a Class B digital device, pursuant to part 15 of the FCC Rules. These limits are designed to provide reasonable protection against harmful interference in a residential installation. This equipment generates, uses and can radiate radio frequency energy and, if not installed and used in accordance with the instructions, may cause harmful interference to radio communications. However, there is no guarantee that interference will not occur in a particular installation. If this equipment does cause harmful interference to radio or television reception, which can be determined by turning the equipment off and on, the user is encouraged to try to correct the interference by one or more of the following measures:

- Reorient or relocate the receiving antenna.
- Increase the separation between the equipment and receiver.
- Connect the equipment into an outlet on a circuit different from that to which the receiver is connected.
- Consult the dealer or an experienced radio/TV technician for help.

### HDMI Trademark Notice

The terms HDMI, HDMI High-Definition Multimedia Interface, HDMI trade dress and the HDMI Logos are trademarks or registered trademarks of HDMI Licensing Administrator, Inc.



### 安全上のご注意

付属品は当該専用品です。他の機器には使用しないでください。機器の破損もしくは、火災や感電の原因となることがあります。

### インターネット回線への接続に関するご注意

本製品は電気通信事業者（移動通信会社、固定通信会社、インターネットプロバイダ等）の通信回線（公衆無線LANを含む）に直接接続することができません。本製品をインターネットに接続する場合は、必ずルーター等を経由し接続してください。

## Australia statement notice

From 1 January 2012 updated warranties apply to all ASUS products, consistent with the Australian Consumer Law. For the latest product warranty details please visit <https://www.asus.com/support/>. Our goods come with guarantees that cannot be excluded under the Australian Consumer Law. You are entitled to a replacement or refund for a major failure and compensation for any other reasonably foreseeable loss or damage. You are also entitled to have the goods repaired or replaced if the goods fail to be of acceptable quality and the failure does not amount to a major failure.

If you require assistance please call ASUS Customer Service 1300 2787 88 or visit us at <https://www.asus.com/support/>.

## Declaration of compliance for product environmental regulation

ASUS follows the green design concept to design and manufacture our products, and makes sure that each stage of the product life cycle of ASUS product is in line with global environmental regulations. In addition, ASUS disclose the relevant information based on regulation requirements.

Please refer to <https://esg.asus.com/Compliance.htm> for information disclosure based on regulation requirements ASUS is complied with:

### EU REACH and Article 33

Complying with the REACH (Registration, Evaluation, Authorisation, and Restriction of Chemicals) regulatory framework, we published the chemical substances in our products at ASUS REACH website at <https://esg.asus.com/Compliance.htm>.

### EU RoHS

This product complies with the EU RoHS Directive. For more details, see <https://esg.asus.com/Compliance.htm>

### India RoHS

This product complies with the "India E-Waste (Management) Rules, 2016" and prohibits use of lead, mercury, hexavalent chromium, polybrominated biphenyls (PBBs) and polybrominated diphenyl ethers (PBDEs) in concentrations exceeding 0.1% by weight in homogenous materials and 0.01% by weight in homogenous materials for cadmium, except for the exemptions listed in Schedule II of the Rule.

### Vietnam RoHS

ASUS products sold in Vietnam, on or after September 23, 2011, meet the requirements of the Vietnam Circular 30/2011/TT-BCT.

Các sản phẩm ASUS bán tại Việt Nam, vào ngày 23 tháng 9 năm 2011 trở về sau, đều phải đáp ứng các yêu cầu của Thông tư 30/2011/TT-BCT của Việt Nam.

### Türkiye RoHS

AEEE Yönetmeliğine Uygundur

### ASUS Recycling/Takeback Services

ASUS recycling and takeback programs come from our commitment to the highest standards for protecting our environment. We believe in providing solutions for you to be able to responsibly recycle our products, batteries, other components as well as the packaging materials. Please go to <https://esg.asus.com/en/Takeback.htm> for detailed recycling information in different regions.



DO NOT throw the motherboard in municipal waste. This product has been designed to enable proper reuse of parts and recycling. This symbol of the crossed out wheeled bin indicates that the product (electrical and electronic equipment) should not be placed in municipal waste. Check local regulations for disposal of electronic products.



DO NOT throw the mercury-containing button cell battery in municipal waste. This symbol of the crossed out wheeled bin indicates that the battery should not be placed in municipal waste.

## France sorting and recycling information



FR

Cet appareil  
et ses accessoires  
se recyclent

À DÉPOSER  
EN MAGASIN



OU

À DÉPOSER  
EN DÉCHÈTERIE



Points de collecte sur [www.quefairedemesdechets.fr](http://www.quefairedemesdechets.fr)  
Privilégiez la réparation ou le don de votre appareil !

## Notices for non Wi-Fi model

### Compliance Statement of Innovation, Science and Economic Development Canada (ISED)

This device complies with Innovation, Science and Economic Development Canada licence exempt RSS standard(s). Operation is subject to the following two conditions: (1) this device may not cause interference, and (2) this device must accept any interference, including interference that may cause undesired operation of the device.

CAN ICES(B)/NMB(B)

### Déclaration de conformité de Innovation, Sciences et Développement économique Canada (ISED)

Le présent appareil est conforme aux CNR d'Innovation, Sciences et Développement économique Canada applicables aux appareils radio exempts de licence. L'exploitation est autorisée aux deux conditions suivantes : (1) l'appareil ne doit pas produire de brouillage, et (2) l'utilisateur de l'appareil doit accepter tout brouillage radioélectrique subi, même si le brouillage est susceptible d'en compromettre le fonctionnement.

CAN ICES(B)/NMB(B)

### Simplified UKCA Declaration of Conformity

ASUSTeK Computer Inc. hereby declares that this device is in compliance with the essential requirements and other relevant provisions of related UKCA Directives. Full text of UKCA declaration of conformity is available at: [www.asus.com/support](http://www.asus.com/support)

### Simplified EU Declaration of Conformity

**English** ASUSTeK Computer Inc. hereby declares that this device is in compliance with the essential requirements and other relevant provisions of related Directives. Full text of EU declaration of conformity is available at: [www.asus.com/support](http://www.asus.com/support)

**Français** ASUSTeK Computer Inc. déclare par la présente que cet appareil est conforme aux critères essentiels et autres clauses pertinentes des directives concernées. La déclaration de conformité de l'UE peut être téléchargée à partir du site Internet suivant : [www.asus.com/support](http://www.asus.com/support)

**Deutsch** ASUSTeK Computer Inc. erklärt hiermit, dass dieses Gerät mit den wesentlichen Anforderungen und anderen relevanten Bestimmungen der zugehörigen Richtlinien übereinstimmt. Der gesamte Text der EU-Konformitätserklärung ist verfügbar unter: [www.asus.com/support](http://www.asus.com/support)

**Italiano** ASUSTeK Computer Inc. con la presente dichiara che questo dispositivo è conforme ai requisiti essenziali e alle altre disposizioni pertinenti con le direttive correlate. Il testo completo della dichiarazione di conformità UE è disponibile all'indirizzo: [www.asus.com/support](http://www.asus.com/support)

**Русский** Компания ASUS заявляет, что это устройство соответствует основным требованиям и другим соответствующим условиям соответствующих директив. Подробную информацию, пожалуйста, смотрите на [www.asus.com/support](http://www.asus.com/support)

**Български** С настоящото ASUSTeK Computer Inc. декларира, че това устройство е в съответствие със съществени изисквания и другите приложими постановления на свързаните директиви. Пълният текст на декларацията за съответствие на ЕС е достъпен на адрес: [www.asus.com/support](http://www.asus.com/support)

**Hrvatski** ASUSTeK Computer Inc. ovim izjavljuje da je ovaj uređaj sukladan s bitnim zahtjevima i ostalim odgovarajućim odredbama vezanih direktiva. Cijeli tekst EU izjave o sukladnosti dostupan je na: [www.asus.com/support](http://www.asus.com/support)

**Čeština** Společnost ASUSTeK Computer Inc. tímto prohlašuje, že toto zařízení splňuje základní požadavky a další příslušná ustanovení souvisejících směrnic. Plné znění prohlášení o shodě EU je k dispozici na adrese: [www.asus.com/support](http://www.asus.com/support)

**Dansk** ASUSTeK Computer Inc. erklærer hermed, at denne enhed er i overensstemmelse med hovedkravene og andre relevante bestemmelser i de relevante direktiver. Hele EU-overensstemmelseserklæringen kan findes på: [www.asus.com/support](http://www.asus.com/support)

**Nederlands** ASUSTeK Computer Inc. verklaart hierbij dat dit apparaat voldoet aan de essentiële vereisten en andere relevante bepalingen van de verwante richtlijnen. De volledige tekst van de EU-verklaring van conformiteit is beschikbaar op: [www.asus.com/support](http://www.asus.com/support)

**Eesti** Käesolevaga kinnitab ASUSTeK Computer Inc, et see seade vastab asjakohaste direktiivide olulistele nõuetele ja teiste asjassepuutuvate sätetele. EL vastavusdeklaratsiooni täielik tekst on saadaval järgmisel aadressil: [www.asus.com/support](http://www.asus.com/support)

**Suomi** ASUSTeK Computer Inc. ilmoittaa täten, että tämä laite on asiaankuuluvien direktiivien olennaisien vaatimusten ja muiden tätä koskevien säädsten mukainen. EU-yhdenmukaisuusilmoituksen koko teksti on luettavissa osoitteessa: [www.asus.com/support](http://www.asus.com/support)

**Ελληνικά** Με το παρόν, η ASUSTeK Computer Inc. δηλώνει ότι αυτή η συσκευή συμμορφώνεται με τις θεμελιώδεις απαιτήσεις και άλλες σχετικές διατάξεις των Οδηγιών της ΕΕ. Το πλήρες κείμενο της δήλωσης συμβατότητας είναι διαθέσιμο στη διεύθυνση: [www.asus.com/support](http://www.asus.com/support)

**Magyar** Az ASUSTeK Computer Inc. ezennel kijelenti, hogy ez az eszköz megfelel a kapcsolódó Irányelvek lényeges követelményeinek és egyéb vonatkozó rendelkezéseinek. Az EU megfelelési nyilatkozat teljes szövege innen letölthető: [www.asus.com/support](http://www.asus.com/support)

**Latviski** ASUSTeK Computer Inc. ar šo paziņo, ka šī ierīce atbilst saistīto Direktīvu būtiskajām prasībām un citiem citiem saistošajiem nosacījumiem. Pilns ES atbilstības paziņojuma teksts pieejams šeit: [www.asus.com/support](http://www.asus.com/support)

**Lietuvių** „ASUSTeK Computer Inc.“ šiuo tvirtina, kad šis įrenginys atitinka pagrindinius reikalavimus ir kitas svarbias susijusių direktyvų nuostatas. Visą ES atitikties deklaracijos tekstą galima rasti: [www.asus.com/support](http://www.asus.com/support)

**Norsk** ASUSTeK Computer Inc. erklærer herved at denne enheten er i samsvar med hovedsaklige krav og andre relevante forskrifter i relaterte direktiver. Fullstendig tekst for EU-samsvarserklæringen finnes på: [www.asus.com/support](http://www.asus.com/support)

**Polski** Firma ASUSTeK Computer Inc. niniejszym oświadcza, że urządzenie to jest zgodne z zasadniczymi wymogami i innymi właściwymi postanowieniami powiązanych dyrektyw. Pełny tekst deklaracji zgodności UE jest dostępny pod adresem: [www.asus.com/support](http://www.asus.com/support)

**Português** A ASUSTeK Computer Inc. declara que este dispositivo está em conformidade com os requisitos essenciais e outras disposições relevantes das Diretivas relacionadas. Texto integral da declaração da UE disponível em: [www.asus.com/support](http://www.asus.com/support)

**Română** ASUSTeK Computer Inc. declară că acest dispozitiv se conformează cerințelor esențiale și altor prevederi relevante ale directivelor conexe. Textul complet al declarației de conformitate a Uniunii Europene se găsește la: [www.asus.com/support](http://www.asus.com/support)

**Srpski** ASUSTeK Computer Inc. ovim izjavljuje da je ovaj uređaj u saglasnosti sa osnovnim zahtevima i drugim relevantnim odredbama povezanih Direktiva. Pun tekst EU deklaracije o usaglašenosti je dostupan da adresi: [www.asus.com/support](http://www.asus.com/support)

**Slovensky** Spoločnosť ASUSTeK Computer Inc. týmto vyhlasuje, že toto zariadenie vyhovuje základným požiadavkám a ostatným príslušným ustanoveniam príslušných smerníc. Celý text vyhlásenia o zhode pre štáty EÚ je dostupný na adrese: [www.asus.com/support](http://www.asus.com/support)

**Slovenščina** ASUSTeK Computer Inc. izjavlja, da je ta naprava skladna z bistvenimi zahtevami in drugimi ustreznimi določbami povezanih direktiv. Celotno besedilo EU-izjave o skladnosti je na voljo na spletnem mestu: [www.asus.com/support](http://www.asus.com/support)

**Español** Por la presente, ASUSTeK Computer Inc. declara que este dispositivo cumple los requisitos básicos y otras disposiciones pertinentes de las directivas relacionadas. El texto completo de la declaración de la UE de conformidad está disponible en: [www.asus.com/support](http://www.asus.com/support)

**Svenska** ASUSTeK Computer Inc. förklarar härmed att denna enhet överensstämmer med de grundläggande kraven och andra relevanta föreskrifter i relaterade direktiv. Fulltext av EU-försäkran om överensstämmelse finns på: [www.asus.com/support](http://www.asus.com/support)

**Türkçe** ASUSTeK Computer Inc., bu aygıtın temel gereksinimlerle ve ilişkili Yönergelerin diğer ilgili koşullarına uyumlu olduğunu beyan eder. AB uygunluk bildiriminin tam metni şu adreste bulunabilir: [www.asus.com/support](http://www.asus.com/support)

**Українська** ASUSTeK Computer Inc. заявляє, що цей пристрій відповідає основним вимогам та іншим відповідним положенням відповідних Директив. Повний текст декларації відповідності стандартам ЄС доступний на: [www.asus.com/support](http://www.asus.com/support)

**Bosnian** ASUSTeK Computer Inc. ovim izjavljuje da je ovaj uređaj usklađen sa bitnim zahtjevima i ostalim odgovarajućim odredbama vezanih direktiva. Kompletan tekst EU deklaracije o usklađenosti dostupan je na: [www.asus.com/support](http://www.asus.com/support)

**עברית** ASUSTeK Computer Inc. בזאת, מצהירה כי משיר זה תואם לדרישות החיוביות ולתנאים הרלוונטיים האחרים של ההחיות הקשורות. הטקסט המלא של הגרסה התאמות של האיחוד האירופי זמין בכתובת: [www.asus.com/support](http://www.asus.com/support)

# Warranty

## EN: ASUS Guarantee Information

- ASUS offers a voluntary manufacturer's Commercial Guarantee.
- ASUS reserves the right to interpret the provisions of the ASUS Commercial Guarantee.
- This ASUS Commercial Guarantee is provided independently and in addition to the statutory Legal Guarantee and in no way affects or limits the rights under the Legal Guarantee.

For all the guarantee information, please visit <https://www.asus.com/support>.

## F: Garantie ASUS

- ASUS fournit une garantie commerciale en tant que garantie volontaire du fabricant.
- ASUS se réserve le droit d'interpréter et de clarifier les informations relatives à la garantie commerciale ASUS.
- Cette garantie commerciale ASUS est fournie indépendamment et parallèlement à la garantie légale, elle n'affecte ou ne limite d'aucune façon les droits acquis par la garantie légale.

Pour plus d'informations sur la garantie, consultez le site <https://www.asus.com/fr/support/>.

## G: ASUS Garantieinformationen

- ASUS bietet eine freiwillige Warengarantie des Herstellers an.
- ASUS behält sich das Recht zur Auslegung der Bestimmungen in der ASUS Warengarantie vor.
- Diese ASUS Warengarantie wird unabhängig und zusätzlich zur rechtmäßigen gesetzlichen Garantie gewährt und beeinträchtigt oder beschränkt in keiner Weise die Rechte aus der gesetzlichen Garantie.

Die vollständigen Garantieinformationen finden Sie unter <https://www.asus.com/de/support/>.

## I: Informativa sulla Garanzia ASUS

- ASUS offre una Garanzia Commerciale volontaria del produttore.
- ASUS si riserva il diritto di interpretare le disposizioni della Garanzia Commerciale ASUS.
- La presente Garanzia Commerciale ASUS viene fornita in modo indipendente e in aggiunta alla Garanzia Legale prevista per legge e non pregiudica o limita in alcun modo i diritti previsti dalla Garanzia Legale.

Per tutte le informazioni sulla garanzia, visitare <https://www.asus.com/it/support>.

## R: Информация о гарантии ASUS

- ASUS предлагает добровольную гарантию от производителя.
- ASUS оставляет за собой право интерпретирование положений гарантии ASUS.
- Настоящая гарантия ASUS никоим образом не ограничивает Ваши права, предусмотренные локальным законодательством.

Для получения полной информации о гарантии посетите <https://www.asus.com/ru/support/>.

## BG: Информация за гаранцията от ASUS

- ASUS предлага доброволна търговска гаранция от производителя.
- ASUS си запазва правото да тълкува условията на търговската гаранция на ASUS.
- Тази търговска гаранция на ASUS се предлага независимо от и в допълнение на законовата гаранция. Тя по никакъв начин не оказва влияние върху правата на потребителя в законовата гаранция и по никакъв начин не ги ограничава.

За цялостна информация относно гаранцията, моля, посетете <https://www.asus.com/support>.

## CR: Informacije o ASUS jamstvu

- ASUS dragovoljno nudi komercijalno proizvođačko jamstvo.
- ASUS zadržava prava na tumačenje odredbi ASUS komercijalnog jamstva.
- Ovo ASUS komercijalno jamstvo daje se neovisno i kao dodatak zakonskom jamstvu i ni na koji način ne ograničuje prava iz okvira zakonskog jamstva.

Sve informacije o jamstvu potražite na <https://www.asus.com/support>.

## CZ: Informace o záruce společnosti ASUS

- Společnost ASUS nabízí dobrovolnou komerční záruku výrobce.
- Společnost ASUS si vyhrazuje právo vykládat ustanovení komerční záruky společnosti ASUS.
- Tato komerční záruka společnosti ASUS je poskytována nezávisle a jako doplněk zákonné záruky a žádným způsobem neovlivňuje ani neomezuje práva vyplývající ze zákonné záruky.

Všechny informace o záruce najdete na adrese <https://www.asus.com/cz/support/>.

## DA: ASUS garantioplysninger

- ASUS tilbyder en valgfri handelsmæssig garanti.
- ASUS forbeholder sig retten til at fortolke bestemmelserne i ASUS' handelsmæssige garanti.
- Denne handelsmæssige garanti fra ASUS tilbydes uafhængigt, som en tilføjelse til den lovbestemte juridiske garanti og den påvirker eller begrænser på ingen måde rettighederne i den juridiske garanti.

Alle garantioplysningerne kan findes på <https://www.asus.com/dk/support/>.

## DU: ASUS-garantie-informatie

- ASUS biedt een vrijwillige commerciële garantie van de fabrikant.
- ASUS behoudt zich het recht voor om de bepalingen van de commerciële garantie van ASUS uit te leggen.
- Deze commerciële garantie van ASUS wordt onafhankelijk en als aanvulling op de statutaire Wettelijke garantie geboden en beïnvloedt of beperkt in geen geval de rechten onder de wettelijke garantie.

Voor alle informatie over de garantie, gaat u naar <https://www.asus.com/nl/support/>.

## EE: Teave ASUS-e garantii kohta

- ASUS pakub vabatahtlikku tasulist tootjagarantiid.
- ASUS jätab endale õiguse õiguse ASUS-e tasulise garantii tingimusi.
- See ASUS-e tasuline garantii on sõltumatu lisagarantii seadusega kehtestatud garantiile ega mõjuta mingil määral seadusega kehtestatud garantiid ning seadusega kehtestatud garantii piiranguid.

Vaadake garantiga seotud teavet veebisaidilt <https://www.asus.com/ee/>.

## FI: ASUS-takuutiedot

- ASUS tarjoaa vapaaehtoisien valmistajan kaupallisen takuun.
- ASUS pidättää oikeuden tulkita ASUS-kaupallisen takuun ehdot.
- Tämä ASUS-kaupallinen takuu tarjotaan itsenäisesti lakisäätöisen oikeudellisen takuun lisäksi eikä se vaikuta millään tavoin laillisen takuun oikeuksiin tai rajoita niitä.

Saadaksesi kaikki takuutiedot, siirry osoitteeseen <https://www.asus.com/fi/support>.

## GK: Πληροφορίες εγγύησης ASUS

- Η ASUS προσφέρει μια εθελοντική Εμπορική εγγύηση κατασκευαστή.
- Η ASUS διατηρεί το δικαίωμα ερμηνείας των διατάξεων της Εμπορικής εγγύησης ASUS.
- Αυτή η Εμπορική εγγύηση ASUS παρέχεται ανεξάρτητα και επιπροσθέτως της θεσμικής Νομικής εγγύησης και σε καμία περίπτωση δεν επηρεάζει ή περιορίζει τα δικαιώματα βάσει της Νομικής εγγύησης.

Για όλες τις πληροφορίες εγγύησης, επισκεφθείτε τη διεύθυνση <https://www.asus.com/gr/el/>.

## HUG: ASUS garanciális információk

- Az ASUS önkéntes gyártói kereskedelmi garanciát kínál.
- Az ASUS fenntartja magának a jogot, hogy értelmezze az ASUS kereskedelmi garanciára vonatkozó rendelkezéseket.
- Ezt a kereskedelmi garanciát az ASUS függetlenül és a törvényes garancia mellett nyújtja és semmilyen módon nem befolyásolja, vagy korlátozza a jogi garancia nyújtotta jogokat.

A garanciára vonatkozó teljes körű információért látogasson el a [https://www.asus.com/hu/support\\_oldalra](https://www.asus.com/hu/support_oldalra).

## LT: Informacija apie ASUS garantiją

- ASUS siūlo savanorišką komercinę gamintojo garantiją.
- ASUS pasilieka teisę savo nuostoriai aiškinti šios komercinės ASUS garantijos nuostatas.
- Ši komercinė ASUS garantija suteikiama nepriklausoma, be įstatyminės teisinės garantijos, ir jokiū būdu nepaveikia ar nepriboja teisinės garantijos suteikiamų teisių.

Norėdami gauti visą informaciją apie garantiją, apsilankykite <https://www.asus.com/lt/>.

## LV: ASUS garantijas informācija

- ASUS piedāvā brīvprātīgu ražotāja komerciālo garantiju.
- ASUS patur tiesības interpretēt ASUS komerciālās garantijas noteikumus.
- Šī ASUS komerciālā garantija tiek piedāvāta neatkarīgi un papildus likumā noteiktajai juridiskajai garantijai, un tā nekādā neietekmē vai neierobežo juridiskajai garantijai noteiktās tiesības.

Lai iegūtu informāciju par garantiju, apmeklējiet vietni <https://www.asus.com/lv/>.

## **MX: Garantía y Soporte**

Esta Garantía aplica en el país de compra. Usted acepta que en esta garantía:

- Los procedimientos de servicio pueden variar en función del país. Algunos servicios y/o piezas de reemplazo pudieran no estar disponibles en todos los países.
- Algunos países pueden tener tarifas y restricciones que se apliquen en el momento de realizar el servicio, visite el sitio de soporte de ASUS en <https://www.asus.com/mx/support/> para ver más detalles.
- Si tiene alguna queja o necesidad de un centro de reparación local o el periodo de garantía del producto ASUS, por favor visite el sitio de Soporte de ASUS en <https://www.asus.com/mx/support/> para mayores detalles.

## **Información de contacto ASUS**

Esta garantía está respaldada por:  
ASUSTek Computer Inc.  
Centro de Atención ASUS +52 (55) 1946-3663

## **NW: Informasjon om ASUS-garanti**

- ASUS tilbyr som produsent en frivillig kommersiell garanti.
- ASUS forbeholder seg retten til å tolke bestemmelsene i ASUS sin kommersielle garanti.
- ASUS sin kommersielle garanti gis uavhengig og i tillegg til den lovbestemte juridiske garantien, og verken påvirker eller begrenser rettighetene under den juridiske garantien på noen måte.

Du finner fullstendig informasjon om garanti på <https://www.asus.com/no/support/>.

## **PG: Informações de Garantia ASUS**

- A ASUS oferece uma Garantia Comercial voluntária do fabricante.
- A ASUS reserva o direito de interpretar as disposições da Garantia Comercial da ASUS.
- Esta Garantia Comercial da ASUS é fornecida de forma independente além da Garantia Legal estatutária e não afeta nem limita de qualquer forma os direitos estabelecidos na Garantia Legal.

Para consultar todas as informações sobre a garantia, visite <https://www.asus.com/pt/support/>.

## **PL: Informacje o gwarancji firmy ASUS**

- Firma ASUS oferuje dobrowolną gwarancję handlową producenta.
- Firma ASUS zastrzega sobie prawo do interpretacji warunków gwarancji handlowej firmy ASUS.
- Niniejsza gwarancja handlowa firmy ASUS jest udzielana niezależnie, jako dodatek do wymaganej ustawowo gwarancji prawnej i w żaden sposób nie wpływa na prawa przysługujące za mocy gwarancji prawnej ani ich nie ogranicza.

Wszelkie informacje na temat gwarancji można znaleźć na stronie <https://www.asus.com/pl/support>.

## **RO: Informații despre garanția ASUS**

- ASUS oferă o garanție comercială voluntară a producătorului.
- ASUS își rezervă dreptul de a interpreta prevederile garanției comerciale ASUS.
- Această garanție comercială ASUS este oferită independent și în plus față de garanția obligatorie legală și nu afectează sau limitează în niciun fel drepturile acordate conform garanției legale.

Pentru toate informațiile legate de garanție, vizitați <https://www.asus.com/ro/support>.

## **S: Información de garantía de ASUS**

- ASUS ofrece una garantía comercial voluntaria del fabricante.
- ASUS se reserva el derecho de interpretar las disposiciones de esta garantía comercial de ASUS.
- Esta garantía comercial de ASUS se proporciona de forma independiente y adicional a la garantía estatutaria y de ninguna manera afecta a los derechos bajo la garantía legal ni los limita.

Para obtener toda la información sobre la garantía, visite <https://www.asus.com/ES/support/>.

## **SB: Informacije o ASUS garanciji**

- ASUS nudi dobrovoljnu proizvođačku komercijalnu garanciju.
- ASUS zadržava pravo da tumači odredbe svoje ASUS komercijalne garancije.
- Ova ASUS komercijalna garancija daje se nezavisno, kao dodatak zakonskoj pravnoj garanciji, i ni na koji način ne utiče na i ne ograničava prava data pravnom garancijom.

Za sve informacije o garanciji, posetite <https://www.asus.com/support/>.

## **SK: Informácie o záruke ASUS**

- ASUS ponúka dobrovoľnú obchodnú záruku výrobcu.
- ASUS si vyhradzuje právo interpretovať ustanovenia obchodnej záruky ASUS.
- Táto obchodná záruka ASUS je poskytnutá nezávisle a navyše k zákonnej záruke a v žiadnom prípade neovplyvňuje ani neobmedzuje tieto práva podľa tejto zákonnej záruky.

Všetky ďalšie informácie o záruke nájdete na <https://www.asus.com/sk/support>.

## **SL: Informacije o garanciji ASUS**

- ASUS ponuja prostovoljno tržno garancijo proizvajalca.
- ASUS si pridržuje pravico do razlage določb tržne garancije družbe ASUS.
- Ta tržna garancija družbe ASUS je na voljo neodvisno in kot dodatek zakonsko predpisani pravni garanciji ter na noben način ne vpliva na pravice, ki jih zagotavlja pravna garancija, oziroma jih omejuje.

Vse informacije o garanciji najdete na spletnem mestu <https://www.asus.com/support>.

## **SW: ASUS garantiinformation**

- ASUS erbjuder en frivillig kommersiell tillverkningsgaranti.
- ASUS förbehåller sig rätten att tolka bestämmelserna i ASUS kommersiella garanti.
- Denna kommersiella garanti från ASUS tillhandahålls separat och som tillägg till den lagstadgade garantin, och påverkar eller begränsar på intet sätt rättsföretagets under den lagstadgade garantin.

För all garantiinformation, besök <https://www.asus.com/se/support/>.

## **TR: ASUS Garanti Bilgileri**

- ASUS, gönüllü olarak üretici Ticari Garantisini sunar.
- ASUS, ASUS Ticari Garantisinin hükümlerini yorumlama hakkını saklı tutar.
- Bu ASUS Ticari Garantisini, bağımsız olarak ve hukuki Yasal Garanti'ye ek olarak sağlanır ve hiçbir şekilde Yasal Garanti kapsamındaki hakları etkilemez veya sınırlamaz.

Tüm garanti bilgileri için lütfen <https://www.asus.com/tr/support> adresini ziyaret edin.

## **UA: Інформація про Гарантію ASUS**

- ASUS пропонує добровільну Комерційну Гарантію виробника.
- ASUS застерігає за собою право тлумачити положення Комерційної Гарантії ASUS.
- Цю Комерційну Гарантію надано незалежно і на додаток до обов'язкової Закonnéї Гарантії; вона жодним чином не впливає на права за Закonnéю Гарантією і не обмежує їх.

Всю інформацію про гарантію подано тут: <https://www.asus.com/ua/support>.

Компанія ASUS не несе відповідальності за шкodu, заподіяну життям, здоров'ям чи майну користувача або інших осіб внаслідок використання несправного Виробу або такого Виробу, що не пройшов діагностику після закінчення терміну служби.

З метою перевірки технічного стану Виробу та визначення безпеки його подальшого використання після закінчення терміну служби користувачу необхідно припинити використання Виробу та передати його в авторизований сервісний центр компанії ASUS протягом одного місяця з моменту виявлення пошкодження та/або закінчення терміну служби Виробу.

## **BP: Informações de garantia ASUS**

Esta garantía aplica-se ao período definido pela garantía legal (90 dias) mais o período de garantía comercial oferecido pela ASUS. Por exemplo, 12M significa 12 meses de garantía no total (3 meses de garantía legal mais 9 meses de garantía contratual), 24 meses significa 24 meses de garantía no total (3 meses de garantía legal mais 21 meses de garantía contratual) e 36 meses significa 36 meses de garantía no total (3 meses de garantía legal e 33 de garantía contratual) a contar da data da garantía declarada (Data de Inicio da Garantia).

Para todas as informações de garantía, visite <https://www.asus.com/br/support/>.

**VN: Thông tin đảm bảo của ASUS**

- ASUS cung cấp Bảo hành thương mại tự nguyện của nhà sản xuất.
- ASUS bảo lưu quyền giải thích các điều khoản của Bảo hành thương mại của ASUS.
- Bảo hành thương mại này của ASUS được cung cấp độc lập và ngoài Bảo đảm pháp lý theo luật định và không có cách nào ảnh hưởng đến hoặc giới hạn các quyền theo Bảo lãnh pháp lý. Để biết tất cả các thông tin bảo hành, vui lòng truy cập

<https://www.asus.com/vn/support>

**ID: Informasi Garansi ASUS**

Periode garansi untuk Mainboard adalah 0 bulan dan Mainboard Workstation adalah 72 bulan Masa ("Garansi") sejak tanggal produk pertama kali dibeli oleh pelanggan akhir ("Tanggal Pembelian"). \* Silakan kunjungi situs Dukungan ASUS di <https://www.asus.com/id/support/warranty-status-inquiry/> untuk detail lebih lanjut. Jika bukti pembelian tidak dapat diberikan, tanggal produksi yang dicatat oleh ASUS akan dianggap sebagai awal dari Masa Garansi. Silahkan pindai Kode QR di bagian bawah halaman terakhir untuk Kartu Garansi versi Web dalam format PDF untuk lebih informasi jelas mengenai jaminan garansi Produk ASUS. Layanan Call Center Nomor Telepon: 1500128 (Senin-Jumat 09.30-17.00, Sabtu 09.30-12.00)

**:HB מידע על אחריות ASUS**

- ASUS מציעה אחריות מסחרית של יצרן מרצון.
- ASUS שומרת לעצמה את הזכות לפרש את הוראות הערבות המסחרית של ASUS
- אחריות מסחרית זו של ASUS ניתנת באופן עצמאי ובנוסף לערבות המשפטית ההסטורית ואינה משפיעה או מגבילה בשום אופן את הזכויות במסגרת הערבות המשפטית.

לימידע אודות האחריות, אנא בקר ב  
<https://www.asus.com/support>

| No. | Kota          | Provinsi   | Alamat  | Jam Kerja                                  |
|-----|---------------|------------|---|--|
| 1   | Jakarta Pusat | Jakarta    | Ruko Mangga Dua Mall No. RM-22, Jl. Mangga Dua Raya No.1, RT.1/RW.12, Mangga Dua Sel., Kecamatan Sawah Besar, Kota Jakarta Pusat, Daerah Khusus Ibukota Jakarta 10730 | Senin-Jumat 09.30-17.00, Sabtu 09.30-12.00 |
| 2   | Surabaya      | Jawa Timur | Jl. Klampis Jaya No. 39, Surabaya, Jawa Timur, Indonesia, 60117   | Senin-Jumat 09.30-17.00, Sabtu 09.30-12.00 |
| 3   | Denpasar      | Bali       | Jl. Teuku Umar Barat No.888D, Denpasar, Bali, Indonesia, 80117  | Senin-Jumat 09.30-17.00, Sabtu 09.30-12.00 |



Warranty Card (Online)

## ASUS contact information

### **ASUSTeK COMPUTER INC.**

Address: 1F., No. 15, Lide Rd., Beitou Dist., Taipei City 112  
<https://qr.asus.com/ProductSafety>

### **ASUS COMPUTER INTERNATIONAL (America)**

Address: 48720 Kato Rd., Fremont, CA 94538, USA

### **ASUS COMPUTER GmbH (Germany and Austria)**

Address: Harkortstrasse 21-23, 40880 Ratingen, Germany

### **ASUSTeK (UK) LIMITED**

Address: 1st Floor, Sackville House, 143-149 Fenchurch Street, London, EC3M 6BL, England,  
United Kingdom

### **ASUS GLOBAL PTE. LTD.**

Address: 10 Changi Business Park Central 2 #02-01 Hansapoint Singapore 486030  
<https://qr.asus.com/ProductSafety>

## Service and support

Visit our multi-language website at <https://www.asus.com/support>.



## Product register

Log in and register your device for better product support.

